



**Solar Inverters**

---

**INSTALLATION AND OPERATOR'S  
MANUAL**

---

**REVISION TABLE**

Document Revision	Author	Date	Change Description
1.0	Falcon.Tang	08/11/2012	First release
			-



**SAVE THESE INSTRUCTIONS !**



**IMPORTANT SAFETY INSTRUCTIONS**

**JFY-tech:** Reproduction and disclosure of the contents of this manual are strictly forbidden without prior authorization of JFY-tech.

## **GENERAL PRECAUTIONS**

For your own safety and that of the unit, you must read and understand the instructions contained in this document before starting to work.

Keep these instructions in a place accessible to all the personnel who work with the unit so that these may be consulted.

Only professional technician may install and operate our units.

### **WARNING:**



To avoid risk of electric shock from energy stored in capacitor, please wait for at least 5 minutes to access the conductor part of input or output terminals of the inverter after it is disconnected from the output of PV panel and AC grid.

There is a fuse in our units. For continued protection against risk of fire, replace only with same type and ratings of fuse. The replacement should be done by qualified service personnel.







- The installation of inverter must be performed in full compliance with the relative local standards and regulations. Keep away from flammable, explosive materials to avoid fire disaster
- No spare parts in package box. To avoid risk of electric shock, Do not remove machine cover. No user serviceable parts inside. Refer servicing to qualified service personnel. Please contact your reseller if you need to know the nearest authorized repair center or qualified service personnel.
- As a qualified service personnel, you should know both ac and dc voltage sources are terminated inside this units. Each circuit must be individually disconnected before servicing.
- Read and understand all the instructions contained in this manual and become familiar with the safety symbols in the relevant paragraphs before you install and commission the equipment.
- The connection to the AC grid must be done only after receiving approval from the administering authority as required by national and state interconnection regulations, and can be done only by qualified personnel.
- Keep the whole surface of the photovoltaic panel covered with material opaque to solar radiation before connecting panel to equipment; this will ensure that no dangerous high voltage is present at the connection cables.
- This unit is designed to feed power to the public power grid (utility) only. Do not connect this unit to an AC source or generator. Connecting Inverter to external devices could result in serious damage to your equipment. By the way, we have special types for these applications. If you are interested, please contact your local dealer.

- Although designed to meet all safety requirements, some parts and surfaces of Inverter are still hot during operation. To reduce the risk of injury, do not touch the heat sink at the back of the solar inverter or nearby surfaces while Inverter is operating. By the way, keep it away from any flammable objects.
- This version of JFY-TECH inverters shall be used with panels connected in a “floating” way. Earthing of one of live conductors of PV panel is not permitted.

The equipment is provided with several labels, some of them with a yellow background, which are related to safety issues.

Make sure to read the labels and fully understand them before installing the equipment.

The symbols are:

	Equipment grounding conductor (Main grounding protective earth, PE)
	Alternate Current (AC) value
	Direct Current (DC) value
	Phase
	To avoid risk of electric shock from energy stored in capacitor, please wait for at least 5 minutes to access the conductor part of input or output terminals of the inverter after it is disconnected from the output of PV panel and AC grid.
	Caution: The temperature of metal enclosure may be high during operation.

**Disposal:** Do not dispose of electrical appliances as unsorted municipal waste, use separate collection facilities. Contact you local government for information regarding the collection systems available. If electrical appliances are disposed of in landfills or dumps, hazardous substances can leak into the groundwater and get into the food chain, damaging your health and well-being.

## CONTENT

<b>1. OVERVIEW</b> .....	6
1.1 Basic Features.....	6
1.2 Machine Overview.....	7
<b>2. INSTALLATION</b> .....	9
2.1 Package inspection .....	9
2.2 Selecting the place of installation .....	9
2.3 Fixed on the wall.....	10
2.4 System diagram and connection label .....	12
2.5 Connecting to the AC grid (utility).....	14
2.6 Connecting to PV Panel (DC input) .....	16
<b>3. OPERATION METHOD</b> .....	19
3.1 CONTROL PANEL.....	19
3.2 Operate the Function Key .....	20
3.3 General LCD Display Information .....	28
3.4 State Message In LCD.....	32
<b>4. INVERTER START-UP AND OPERATION</b> .....	35
<b>5. COMMUNICATIONS</b> .....	37
5.1 Data communications with RS232 .....	37
5.2 Data communications with RS485(optional) .....	37
5.2.1 RS485 Serial Port.....	37
5.2.2 RJ45 Connectors.....	38
5.2.3 RS485 Daisy Chain.....	38
5.3 Monitor Inverter.....	40
<b>6. INTERFACE PROTECTION AND SETTING POINTS</b> .....	40
<b>7. TROUBLE SHOOTING</b> .....	41
<b>8. SPECIFICATIONS</b> .....	43
<b>9. JFY-tech WARRANTY</b> .....	46
<b>10. JFY-tech CONTACT INFORMATION</b> .....	48

# 1. OVERVIEW

## 1.1 Basic Features

Congratulations on user purchase of a SUNTREE Series inverter from JFY. The SUNTREE Series inverter is one of the finest inverter on the market today, incorporating state-of-the-art technology, high reliability, and convenient control features.

- Advanced DSP control technology.
- Utilize the latest high-efficiency power component.
- Optimal MPPT technology.
- 2 independent MPP trackers.
- Advanced anti-islanding solutions.
- Max. efficiency up to 98.2%, EU efficiency up to 97.6%.
- THD~3%.
- Power factor adjustable arrange: +/-0.9.
- DC switch (optional).
- Safety & Reliability: Transformerless design with software and hardware protection.
- IP65 protection.
- Friendly HMI.
- LED status indications.
- Multi language LCD display, Human-Machine interaction through button.
- RS485/RS232 communication interface.
- PC remote control.

## 1.2 Machine Overview

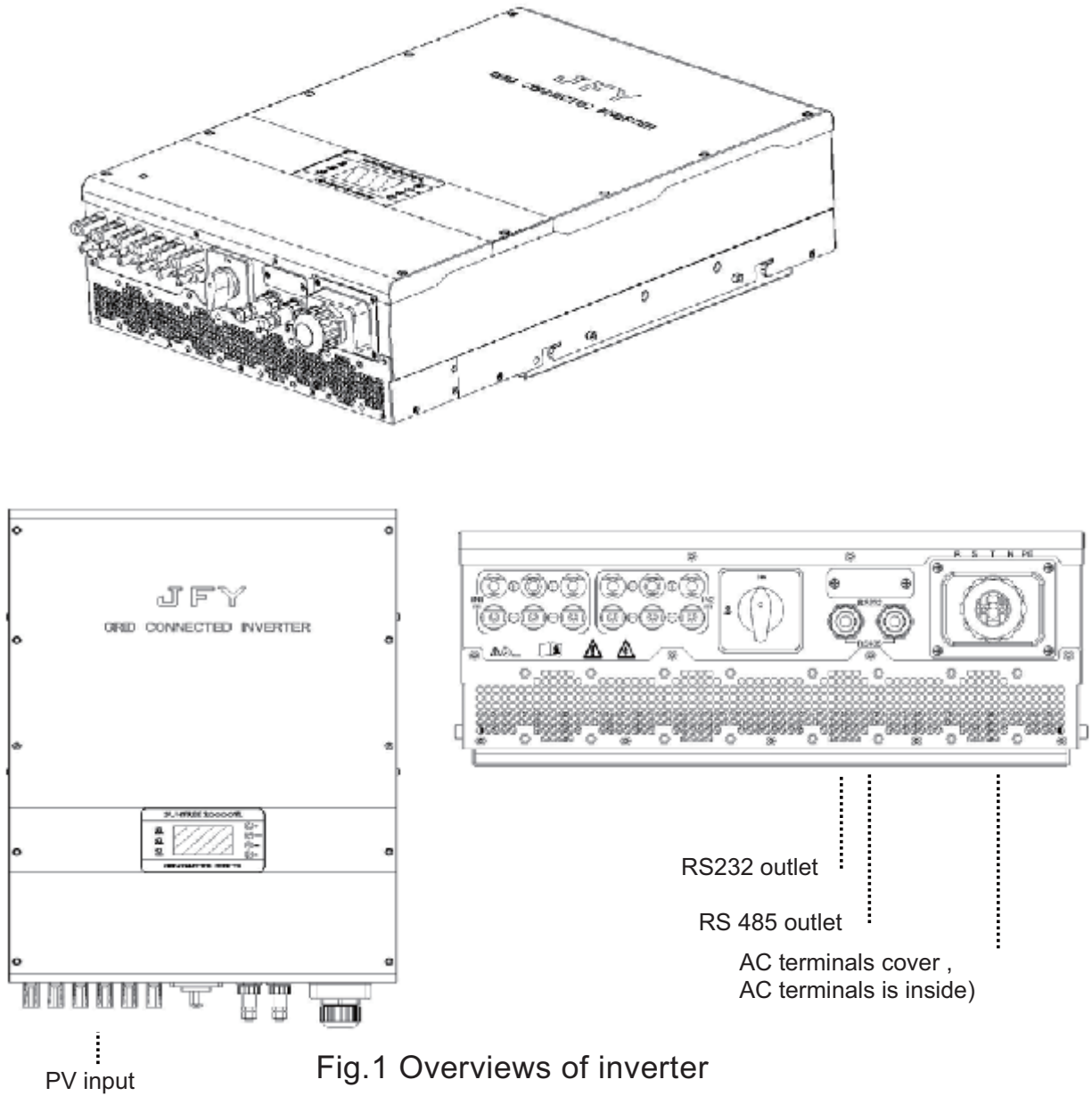

Fig.1 Overviews of inverter

### Opening the package

After opening the package, please check the contents of the box. It should contain the following accessories:

Item	Name	Quantity
1.	Solar inverter	1pcs
2.	Mounting frame	1pcs
3.	Mounting screws and blocks	9pcs
4.	Safety-lock screws	4pcs
5.	Socket head wrench	1pcs
6.	DC socket assembly	1set
7.	Special RS-232 cable	1pcs
8.	Instruction manual	1pcs
9.	Monitor software(CD)	1pcs
10.	Warranty sheet	1pcs

**SUNTREE xxxxxTL series include SUNTREE 15000TL/17000TL/20000TL**



## 2. INSTALLATION



**WARNING:** The electrical installation of JFY-TECH inverter must be performed in compliance with applicable local and national standards and laws.



**WARNING:** The connection of JFY-TECH inverter to the AC grid must be performed only after receiving authorization from the utility that operates the grid.

### 2.1 Package Inspection

The customer is encouraged to perform the following checks:

- Inspect the package box for apparent damage, such as holes, cracking or any sign of possible damage to its contents.
- Describe any damage or shortage on the receiving documents and have the carrier sign his/her full name.
- Open the package box and inspect the contents for internal damage. While unpacking, be careful not to discard any equipment, parts or manuals. If any damage is detected, call the delivering carrier to determine the appropriate action. Save all shipping material for the event the carrier sends an inspector to verify damage!
- If the inspection reveals damage to the inverter, please call your local supplier or the authorized distributor. They will determine if the equipment should be returned for repair. They will also provide instructions on how to get the equipment repaired;
- It is the customer's responsibility to file a claim with the carrier. Failure to file a claim with the carrier may void all warranty service rights for any damage;
- Carefully store the original packaging of JFY-TECH inverter since it shall be used in case it is necessary to ship it for repair.

### 2.2 Selecting the place of installation

Place of installation should be selected based on the following considerations:

- JFY-TECH inverters shall be set at a suitable height from the ground to enable easy readout view of the display and the LEDs.
- Select a well ventilated place sheltered from direct sun radiation. Choose a place that allows fluent air flow around the unit.
- Allow sufficient room around the unit to enable easy installation and removal of the object from its mounting surface.

The following figure shows the recommended minimum clearances around the inverter:

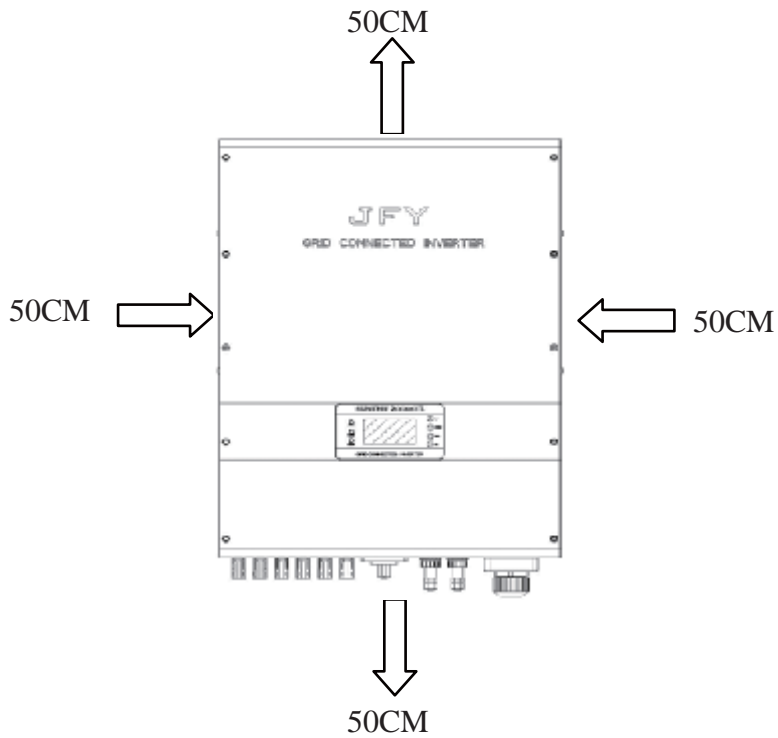

Fig.2 Installing minimum clearances around inverter

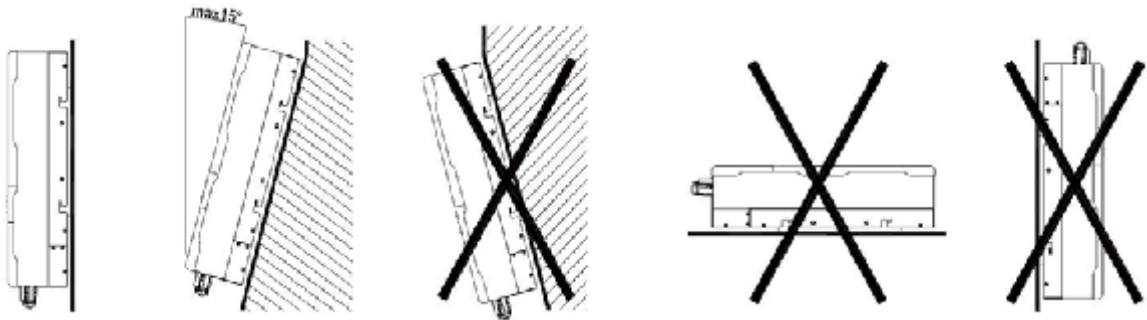

Figure 3 The correct position of the inverter installment

## 2.3 Fixed on the wall

- Step1: Drill 9 holes as illustrated in the Fig.4
- Step2: Fix the mounting frame as illustrated in the Fig.4 by the screws,then, hang the inverter on the mounting frame.
- Step3: Fix safety-lock screws at upper-left side and upper-right side as illustrated in Fig.5 with the attached socket head wench.
- Step4: Check the installation conditions.

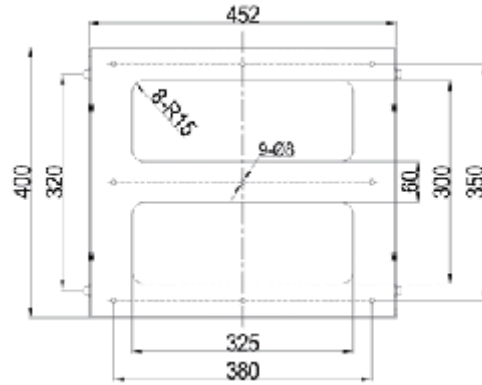

Fig.4 The size of For SUNTREE 15000TL/17000TL/20000TL

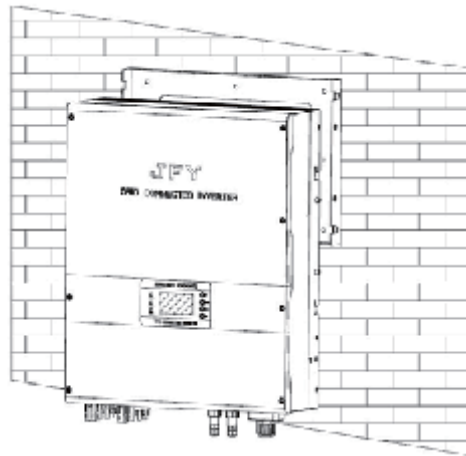

Fig.5 Hang inverter to mounting frame

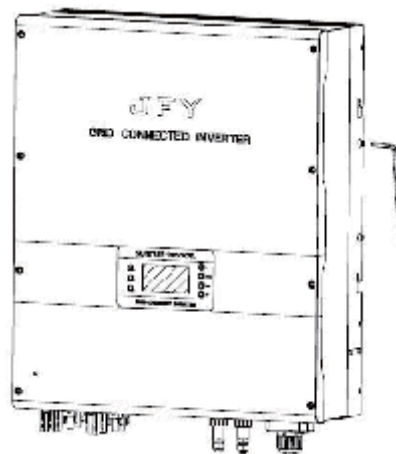

Fig.6 Fix safety-lock screws

The customer is encouraged to perform the following checks:

- Do not install the solar inverter on a gradient surface.
- Check the upper straps of solar inverter and ensure it to fit on to the bracket.
- Ensure safety-lock screws (M5 socket head cap screws) to insert into the mounting frame through inverter's heatsink.
- Check the secure mounting of the solar inverter by trying to raise it from the bottom. The solar inverter should remain firmly attached.
- Choose a strong mounting wall to prevent vibrations while inverter is operating.

## 2.4 System Diagram and Connection Label

The **SUNTREE xxxxxTL** series are a three phase solar inverters. They are responsible for converting the direct current generated by PV panels into three-phase 400Vac 50Hz alternating current for delivery into the AC grid.

The SUNTREE series can be used in an on-grid PV system to produce electricity.

The installation of the **SUNTREE xxxxxTL** and their connection to the AC grid shall be done in accordance with local regulations and may require the installation of adequate electricity consumption measuring devices.

The **SUNTREE xxxxxTL** only operates when it is connected to the AC grid and can not operate as a stand-alone unit.

The simplified connection diagram of the inverter is as follows.



Fig.7 The PV system diagram 1

The simplified connection diagram of the inverter is as follows:

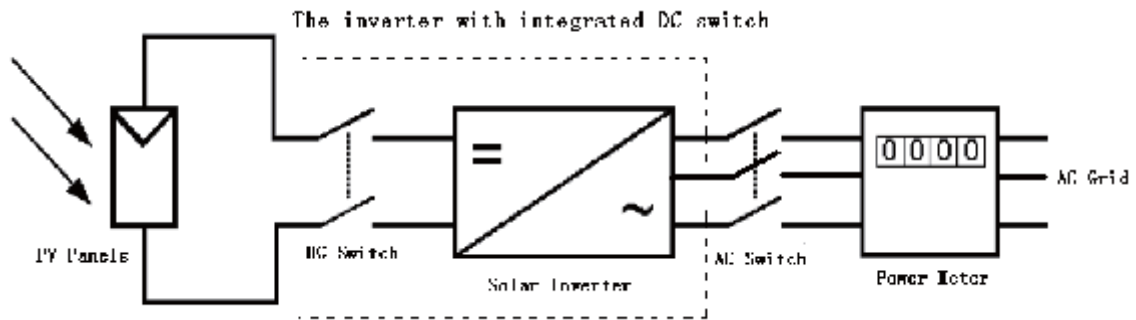

Fig.8 The PV system diagram 2



**NOTE:** Ensure Suntime xxxxxTL is not exposed to direct sun radiation or other external heat sources, including heat from units below it (see fig.6). Indeed, the heat generated by the inverters of the bottom

rows could increase ambient temperature to the detriment of the inverters located in the top rows. At temperature above 50°C, output power of the top row units could be derated.

Derating is more marked in case of high output power and high ambient temperature. For proper cooling, make sure to install inverter so as to allow unobstructed air flow (for instance, never with the front panel facing a solid surface).

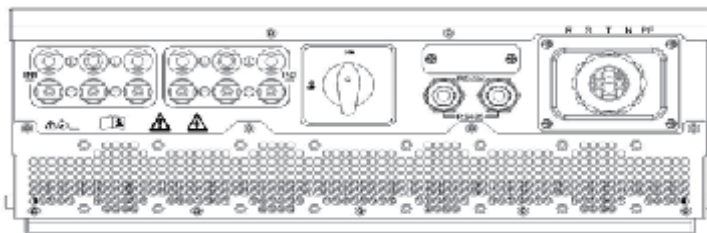

Fig. 9 Connections available on inverter bottom and relevant marking

- A. PV Panels: Provide DC power to inverter.
- B. Solar inverter: Converts DC (Direct Current) power from PV panel(s) to AC (Alternating Current) power. Because Inverter is grid-connected it controls the current amplitude according to the PV Panel power supply. Inverter always tries to convert the maximum power from your PV panel(s).
- C. DC Switch and AC Switch: “DC switch” is between PV Panels and solar inverter while “AC Switch” is between AC Grid (Utility) and solar Inverter. They are simplified in this diagram. In fact, they may consist of electrical breaker, fuse and connecting terminals. To comply with local safety standards and codes, the connection system should be designed and implemented by a qualified technician. JFY-tech also provides the solar inverter with an integrated DC switch

demonstrated in dashed border in Fig.6. –S suffix indicates the inverter is integrated a DC switch in PV input side.

D. AC Grid (Utility): Referred to as “grid” in this manual, is the way your electric power company provides power to your place. Please note that Inverter can only connect to low-voltage systems (namely, 400Vac, 50Hz).

E. PV INPUT: Connected to PV Panels by the attached terminals.

F. RS232: Connected to monitoring computer by special RS232 cable provided by JFY-tech.

G. RS485: daisy-chain communication for one or more inverters.

H. AC TERMINAL (three blocks in right hand): Connected to AC Grid.

**Note:** JFY-tech provides an integrated switch box that includes DC switch, AC switch, DC fuse, AC fuse, DC SPD and AC SPD devices as an option. Of course, you can get similar switch box from your local market.

## 2.5 Connecting to the AC Grid (Utility)

A. Measure AC grid (utility) voltage and frequency. It should be 400VAC ,50Hz and three phase.

B. Open AC Switch between solar inverter and AC Grid (Utility).

C. Open AC terminals cover and connect AC wires on AC terminals as follows, the tightening torque for terminals is 0.56 Nm. The PE terminal is important and necessary to connect with main grounding protective earth by wire.

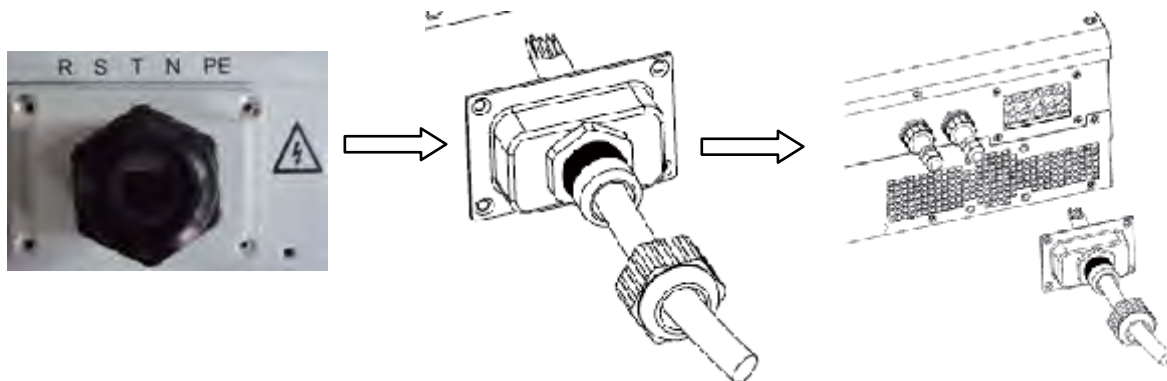

Fig. 10 AC terminals under AC terminals cover

Below is the AC cable specification table when select the cable for installation.

Model	Suntree 15000TL/17000TL	Suntree 20000TL
Cable(Cu)	$\geq 6\text{mm}^2$	$\geq 7\text{mm}^2$
Micro-Breaker	50A	75A



WARNING: When making the electrical connections follow this exact procedure to avoid exposure to dangerous voltages.



WARNING: use suitable low-impedance cables to connect JFY-tech inverter to AC disconnect.



WARNING: SUNTREE series inverter shall be connected to AC disconnect by means of a five-pole cable: three phase cables, one neutral cable and a yellow-green cable for ground (PE).

Lay out the cable between JFY-tech and the AC disconnect connect the three-pole cable to JFY-tech by means of the fairlead on the mechanical parts

Connect the 5 cables as follows:

- Terminal  $\oplus$  for Protective Earth PE
- terminal R for Line R,
- terminal S for Line S.
- terminal T for Line T.
- terminal N for neutral.

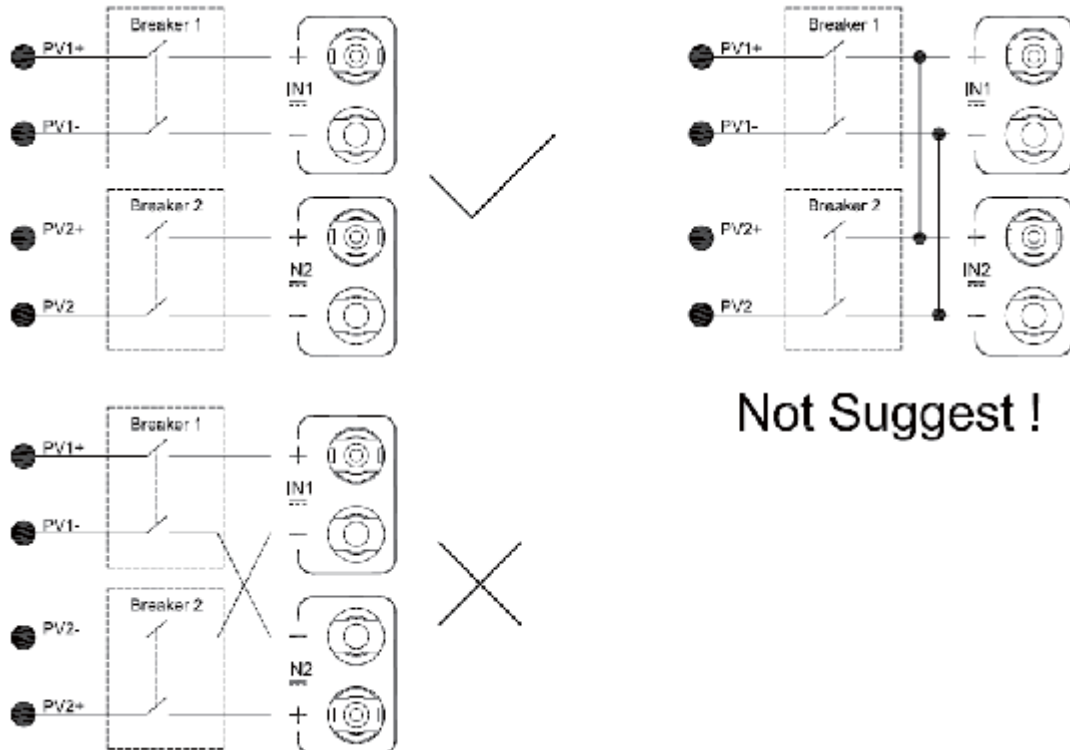

Fig.11 - Terminal board for AC cables connections

WARNING: Do not reverse any phase and neutral as this might make the system unsafe to run and cause malfunctioning.

## 2.6 Connecting to PV Panel (DC input)

- A. **Under any condition!** Make sure the maximum open circuit voltage (Voc) of each PV string is less than 1000VDC for Suntree 15000TL/17000TL and Suntree 20000TL, The length of input wire must be less than 30m. By the way, generally, in the lowest ambient temperature of your installing field, the Voc of PV string is the highest.
- B. Use the attached connectors for PV array terminals.
- C. Open DC Switch and Connect the positive and negative terminals from the PV panel to DC switch, then to positive (+) terminals and negative (-) terminals on the solar inverter. Each DC terminal on inverter can withstand 40Adc.
- D. When connecting PV panels to DC Switch, then, DC Switch to the terminals of inverter, please make sure the polarity is correct.  
**Incorrect polarity connection could permanently damage the unit.** Please confirm short-circuit current of the PV string. The total short-circuit current of the PV string should be less than the inverter's maximum DC input current.
- E. High voltages exist when the PV panel is exposed to the sun. To reduce risk of electric shock, avoid touching live components and treat connection terminals carefully.
- F. To avoid the Electro Magnetic Interference of inverter to the surrounding equipment, the following right connecting way be recommended.







**WARNING:**

When connecting to the AC grid and PV panel, please ensure to disconnect the AC and DC switches.

**Note:** Ensure that photovoltaic field voltage polarity matches the “+” and “-” symbols. Before connecting JFY-TECH inverters with the photovoltaic field, JFY-tech recommends to check, using a proper gauge, that the polarity value and the voltage allowed value between positive and negative contacts are correct.

### 2.6.1 Assemble DC connector

2.6.1.1. Strip the cable 6-8mm, then connect the bare wire core into core tube of connector



Fig.12 Terminal board for DC cables connections

2.6.1.2 Crimp contact barrel by using a hex crimping die. Put the contact barrel with striped cable in the corresponding crimping notch and crimp the contact.

2.6.1.3 Insert the core tube into slot of connection until hear the voice indicating in place.

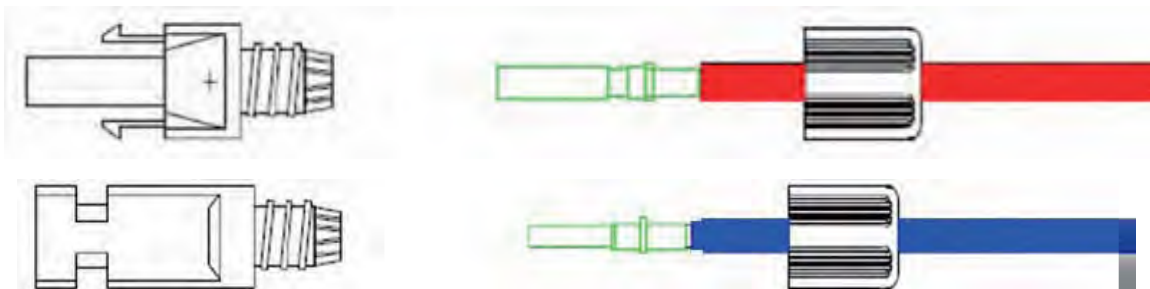

Fig.13

2.6.1.4 Insert contact cable assembly into back of the male and female connector. Tighten nuts according to the opposite direction. Now wiring is finished

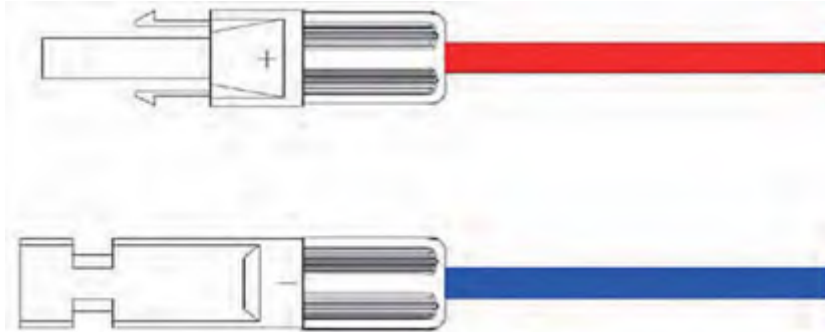

Fig.14

2.6.1.5 The PV importation that will assemble a good DC conjunction machine to make an effort to insert Inverters carries and link OK after hearing the sound of "click"



**WARNING:** Shock hazard! Before removing the panel, disconnect JFY-tech at both the AC and DC side and allow at least 5 minutes for the internal capacitors to discharge.

## 3. Operation Method

### 3.1 CONTROL PANEL

There is an LCD screen, three LEDs and four function key on the front of the solar inverter. The LCD and LED provide you with details of the status of your Inverter. You also can use this Function key as an simple control.



Fig. 16 Control panel

- A. LCD Screen: Display the operating data and situations, warning/error codes and information.
- B. The model of inverter (for example, Suntime 10000TL)
- C. ALARM LED: Indicates the alarm of inverter.
- D. POWER LED: Indicates the inverter is running normally.
- E. Fault LED: Indicates the fault of inverter.
- F. Function Key: Used to set different parameter and display language for the inverter.
- G. Description of inverter

**Note:** To save power, the LCD display's backlight automatically turns off after 10 seconds.

There are 4 buttons on the panel: UP, DOWN, ESC, OK

- ◆ UP button: move cursor to up or increase the values
- ◆ DOWN button: move cursor to down or decrease the values.
- ◆ ESC button: exit current screen or selection
- ◆ OK button: confirm the selection.

LED indicators

Information List	Green LED	Yellow LED	Red LED
Wait State	FLASH	OFF	OFF
Fault Revoer	OFF	ON	OFF
Normal State	ON	OFF	OFF
Fault State	OFF	OFF	ON
Permanent State	ON	OFF	OFF

**Wait State:** Inverter is waiting to Check State until the end of reconnection time. In this state, the PV voltage is more than 250V and grid voltage value is between the max and min limit; Otherwise, Inverter will go to Fault State or Permanent State.

**Fault Revoer:** Inverter is in the process of circulating in take place mistake or breakdown, break down Inverter to re- combine a net after the relief

**Normal State:** Inverter feeds to grid energy from PV panel as much as possible according MPP trackers. Inverter will go to FaultState or PermernentState if any error or fault occurs.

Fault State: Inverter has occurred some recoverable error

Permanent State: Inverter has occurred some unrecoverable error. It will stay in Permenent State. You should take some measure according the error code.

### 3.2 Operate the Function Key

To view the operating data of the inverter, you can press the Function Key. Of course, the data also will automatically and periodically display. To set different display contrast and display language for the inverter, please carefully refert to the following chart.

### 3.2.1 LCD Commissioning setup operation steps

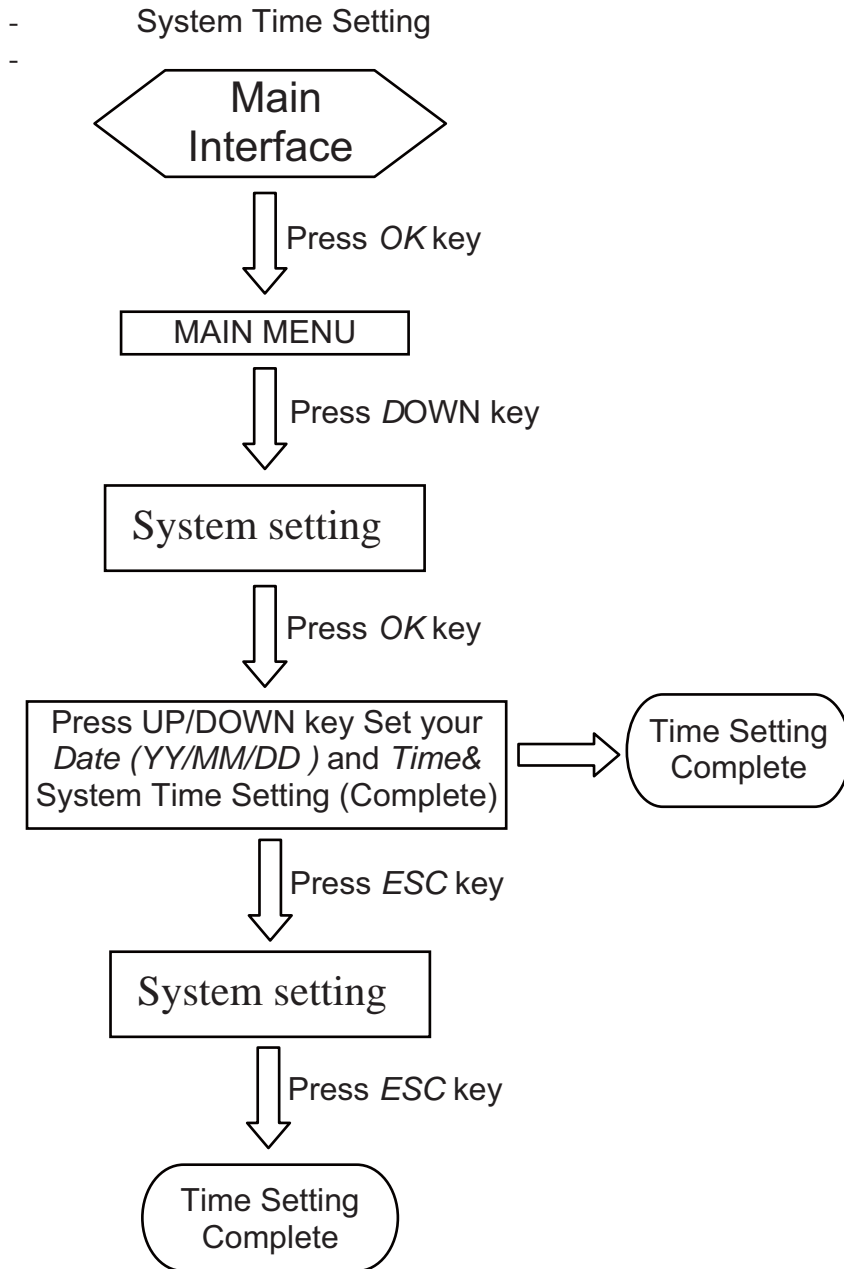

### System Language Setting

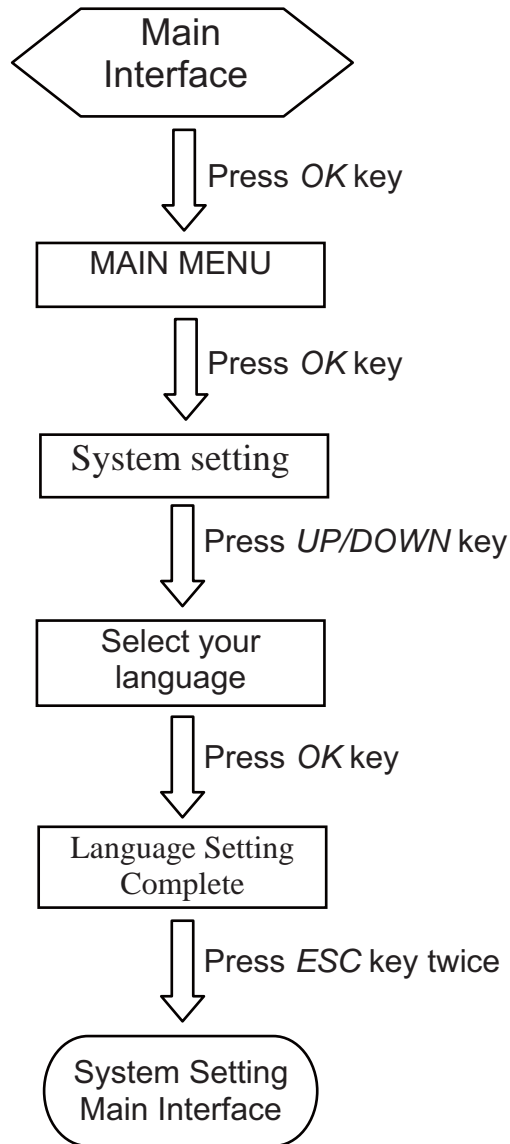

### Audible Alarm Setting

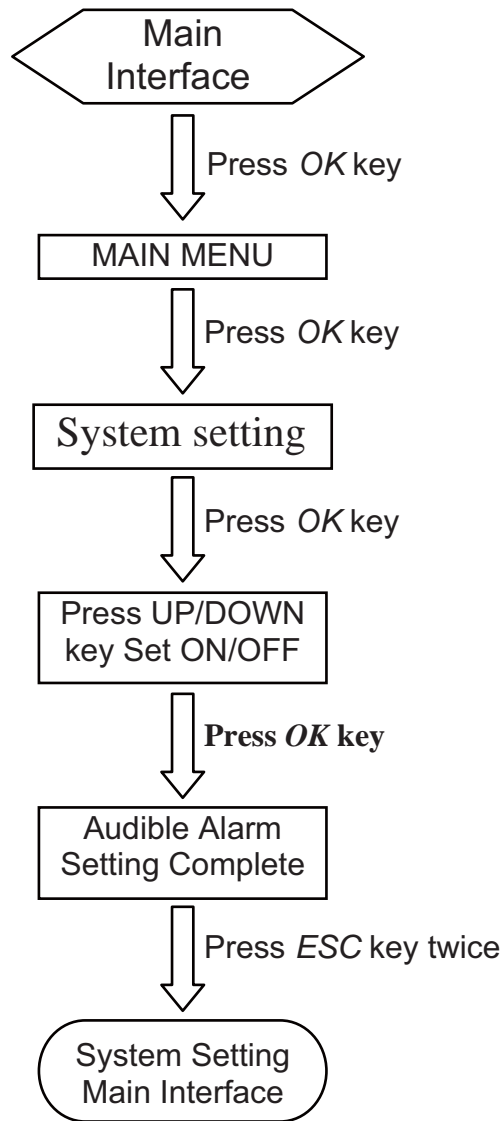

### Power Generation(generated energy) Checking

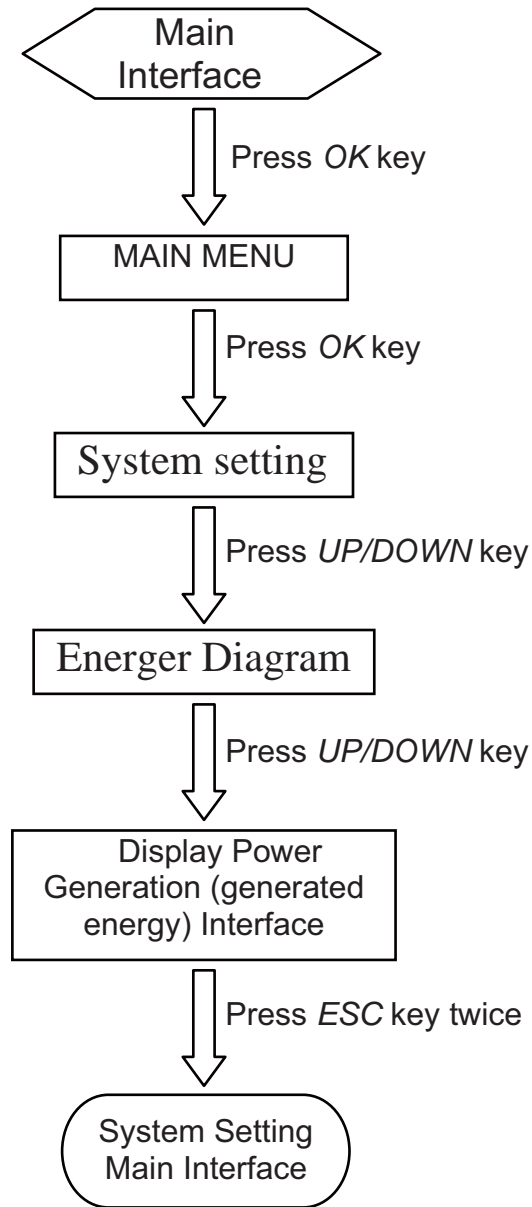



### Checking System Error Code

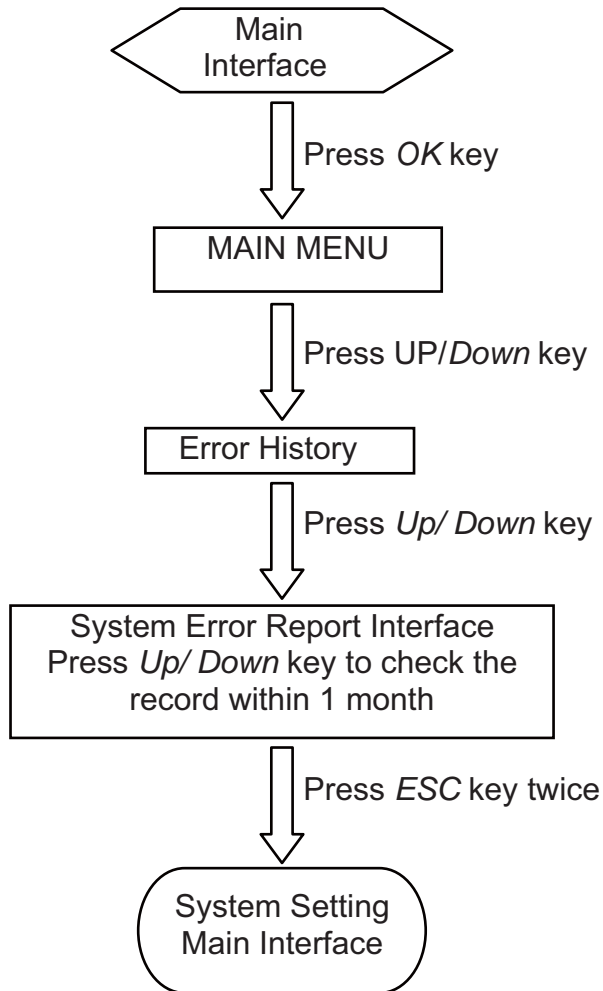

### System Parameters Checking

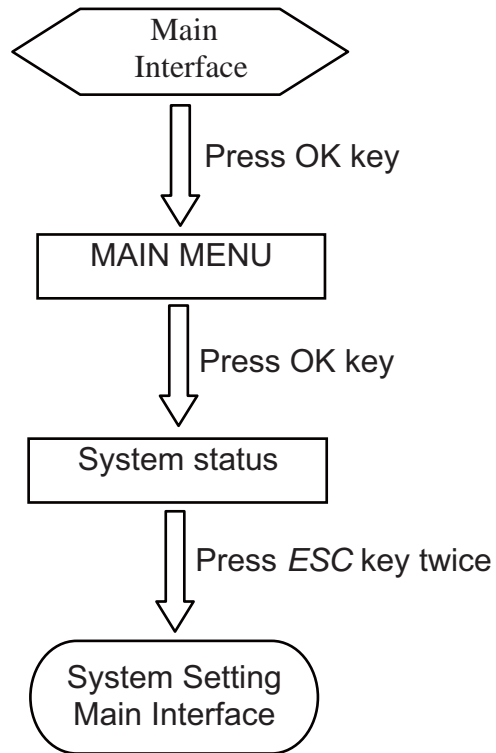

### 3.2.2 Autotest (Only for Italy)

During turn on time, Inverter will test all the electrical parameters, if the test failed, the inverter will not work



Note: The error messages of Inverter testing will specified in section 7 with related solution.

#### 3.2.2.1 PV voltage testing

Inverter test the PV input voltage at the first time before grid-tied. If the voltage below 250V, the inverter will be stay in a standby state. If the voltage is between 250V to 1000V, the inverter pass the test. If the voltage above 1000V, PV OVER Voltage error will be reported.



Note: It will cause unpredictable damage to the inverter if it stay in PV OVER Voltage state. Please turn off the PV input switch immediately and check the solar panel's connection. Turn on the PV input switch after the problems solved.

#### 3.2.2.2 Grid voltage / frequency testing(Only for Italy)

Inverter test the grid voltage, frequency and phase before grid-tied. For Suntree xxxxxTL, the operating voltage range is 184V to 264V(L-N), and the frequency range is 49.5Hz to 51.5 Hz.

#### 3.2.2.3 PV input ISO testing



Inverter test the PV input ISO number before grid-tied. If the number is small than the system setting number, the inverter will not work.

Note: If the ISO test error, the inverter will test repeatedly, Please deal with the inverter according to solution on Section 7.4 when ISO error reported before restart the inverter.

#### 3.2.2.4 GFCI testing

Inverter test the GFCI number before grid-tied and during grid-tied working time. If any wrong, the GFCI error will reported and turn off the the inverter output.



**NOTE:** If the GFCI error reported repeatedly, please turn off the inverter and check the grid connection. Turn on the inverter after problems solved.





**NOTE:** Not only each inverter state is signalled through the relevant LED that comes on or flashes, but the Suntree xxxxxTL LCD also displays a message that identifies the operation in progress or the detected fault/failure

### 3.3 General LCD Display Information

<p>Start:</p>	
<p>Time setting</p>	

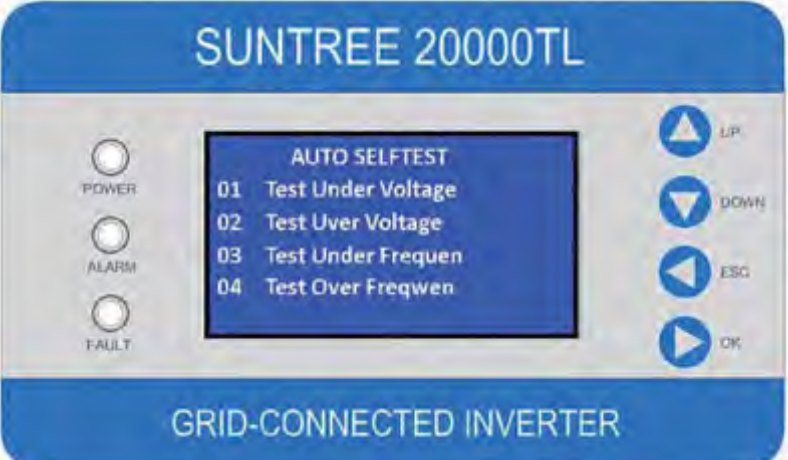
<p>System setting:</p>	 <p>The image shows the 'System Setting' screen of a SUNTREE 20000TL inverter. The screen displays the following information: SN:58211012380001, Mod:SUNTREE-20000TL, Date:2012-08-20, Time:09:12:10, Audible Alarm: ON, and Language: English. The screen is framed by a blue border with 'SUNTREE 20000TL' at the top and 'GRID-CONNECTED INVERTER' at the bottom. On the left side, there are three indicator lights labeled POWER, ALARM, and FAULT. On the right side, there are four navigation buttons labeled UP, DOWN, ESC, and OK.</p>
<p>System status:</p>	 <p>The image shows the 'System Status' screen of a SUNTREE 20000TL inverter. The screen displays the following information: Vdc=500.1V /500.6V, Idc=20.4A /20.3A, Vac=220.6 /221.2/221.1V, Iac=30.3/30.1/30.3A, Pdc=10202W/10162W, Pac=6684/6652/6670W, and Vb=326 / 325 / F=50HZ. The screen is framed by a blue border with 'SUNTREE 20000TL' at the top and 'GRID-CONNECTED INVERTER' at the bottom. On the left side, there are three indicator lights labeled POWER, ALARM, and FAULT. On the right side, there are four navigation buttons labeled UP, DOWN, ESC, and OK.</p>
<p>Main Menu:</p>	 <p>The image shows the 'MAIN MENU' screen of a SUNTREE 20000TL inverter. The screen displays a list of five options: 01 System Status, 02 System Setting, 03 Error History, 04 Energy Diagram, and 05 Auto SelfTest. The screen is framed by a blue border with 'SUNTREE 20000TL' at the top and 'GRID-CONNECTED INVERTER' at the bottom. On the left side, there are three indicator lights labeled POWER, ALARM, and FAULT. On the right side, there are four navigation buttons labeled UP, DOWN, ESC, and OK.</p>

<p>Auto Test Menu: (only for Italy)</p>	 <p>The image shows the SUNTREE 20000TL control panel. The LCD screen displays the 'AUTO SELFTEST' menu with four options: 01 Test Under Voltage, 02 Test Uver Voltage, 03 Test Under Frequen, and 04 Test Over Frequen. The panel includes three indicator lights (POWER, ALARM, FAULT) on the left and four navigation buttons (UP, DOWN, ESC, OK) on the right. The text 'GRID-CONNECTED INVERTER' is visible at the bottom of the panel.</p>
<p>Auto Test-Submenu: (only for Italy)</p>	 <p>The image shows the SUNTREE 20000TL control panel. The LCD screen displays the 'AUTO SELFTEST' submenu with four options: 01 Test Under Voltage (highlighted), 02 Test Over Voltage, 03 Test Under Frequen, and 04 Test Over Frequen. Below the options, it shows 'Test Pass' and 'Lim:230v, Aot:235V'. The panel includes three indicator lights (POWER, ALARM, FAULT) on the left and four navigation buttons (UP, DOWN, ESC, OK) on the right. The text 'GRID-CONNECTED INVERTER' is visible at the bottom of the panel.</p>
<p>Default Display:</p>	 <p>The image shows the SUNTREE 20000TL control panel. The LCD screen displays the default display with the following information: POWER: 20020W, E-TOTAL: 12KWH, and Iac=30.3/20.2/30.3A. The panel includes three indicator lights (POWER, ALARM, FAULT) on the left and four navigation buttons (UP, DOWN, ESC, OK) on the right. The text 'GRID-CONNECTED INVERTER' is visible at the bottom of the panel.</p>





<p>History Record:</p>	<p>The image shows the control panel of a SUNTREE 20000TL Grid-Connected Inverter. The top blue bar contains the model name 'SUNTREE 20000TL'. Below it, on the left, are three indicator lights labeled 'POWER', 'ALARM', and 'FAULT'. The central LCD screen displays 'No Error Record!'. On the right side, there are four navigation buttons: 'UP', 'DOWN', 'ESC', and 'OK'. The bottom blue bar contains the text 'GRID-CONNECTED INVERTER'.</p>
<p>Power Data Reset:</p>	<p>The image shows the control panel of a SUNTREE 20000TL Grid-Connected Inverter. The top blue bar contains the model name 'SUNTREE 20000TL'. Below it, on the left, are three indicator lights labeled 'POWER', 'ALARM', and 'FAULT'. The central LCD screen displays 'Reset All Diagrams?' with instructions: 'Press Enter: Yes' and 'Press Esc: No'. On the right side, there are four navigation buttons: 'UP', 'DOWN', 'ESC', and 'OK'. The bottom blue bar contains the text 'GRID-CONNECTED INVERTER'.</p>
<p>Energy Diagram Menu:</p>	<p>The image shows the control panel of a SUNTREE 20000TL Grid-Connected Inverter. The top blue bar contains the model name 'SUNTREE 20000TL'. Below it, on the left, are three indicator lights labeled 'POWER', 'ALARM', and 'FAULT'. The central LCD screen displays 'ENERGY DIAGRAM' with a list of options: '01 Hourly Diagram', '02 Daily Diagram', '03 Mensal Diagram' (highlighted), '04 Annual Diagram', and '05 Clear Diagram'. On the right side, there are four navigation buttons: 'UP', 'DOWN', 'ESC', and 'OK'. The bottom blue bar contains the text 'GRID-CONNECTED INVERTER'.</p>

Energy  
Diagram:



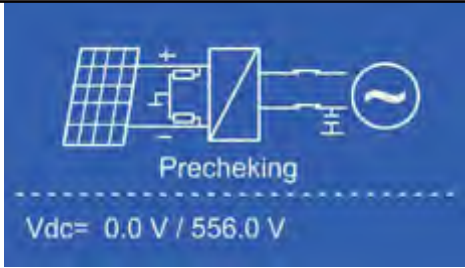

### 3.4 State Message In LCD

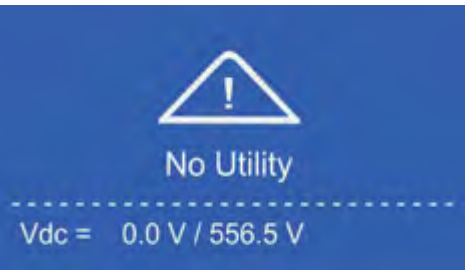
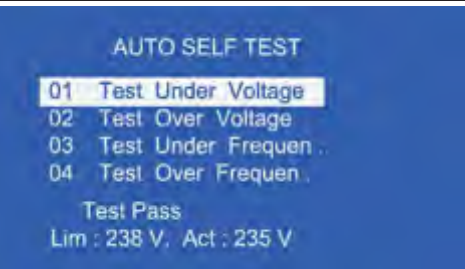
State Message In LCD		
STATE	DISPLAY CONTENT	COMMENTS
Wait State		While PV Voltage > 250V, Inverter Checking , Relay Off
PreChecking State		WhileChecking to 0 second, Relay On
Inverter connection State		Connect to Grid
Fault State		While Error happen, Inverter Alarm and display error message
Auto Test State(only for Italy)		Protection auto test

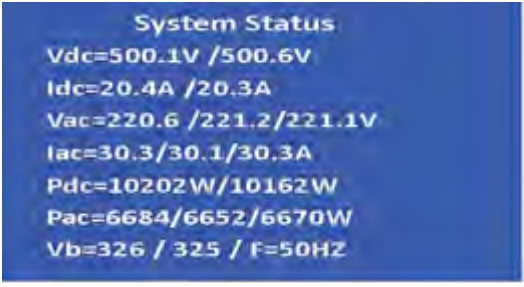
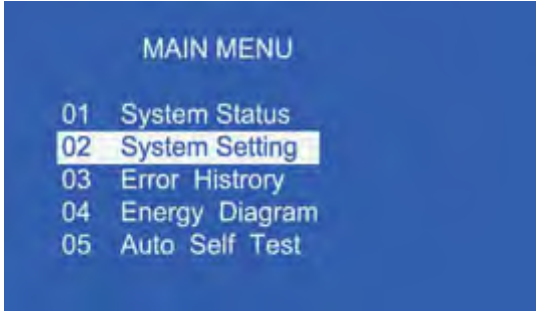
<b>Main Operating Messages In LCD</b>		
<b>STATE</b>	<b>DISPLAY CONTENT</b>	<b>COMMENTS</b>
		Normal display: Display power, Etoday, Etotal
		System Status: Display all Critical parameters
		System Setting: Display Serial number, Model Name, Date, Time, Buzzer Status, Language Type
<b>Note:</b>		

## 4. INVERTER START-UP AND OPERATION



**WARNING:**

Do not place any items on JFY-TECH inverter during operation. When the inverter is operating, do not touch the heat sink since some parts may become very hot.

**Step 1:** Ensure that the AC cable and DC cable is connected correctly, unused DC plugs and AC terminal cover are sealed.

**Step 2:** Connect the DC and AC switches. The inverter starts up automatically when DC-power from the PV strings is sufficient.

Once the solar inverter starts, it enters one of the following 3 states in turn:

Standby: The PV string can only provide just enough voltage to minimum requirements of the internal controller unit.

Waiting: When the PV string DC voltage is greater than 200V, The inverter enters a “waiting” state and attempts to connect to the grid.

Normal: When PV string DC voltage is greater than 300V, Inverter operates in the normal state.

The Inverter will keep MPPT function and deliver power to AC Grid when it is in normal operation. Maybe it will stop under the situation of low input DC-power, Don't worry, it will automatically restart again when DC-power from the PV string is sufficient.

**Error or Warning status**

Inverter is designed to be user-friendly, therefore, the error or warning status of the Inverter can be easily understood by reading the information shown on the front panel display. All possible messages are shown in the following table.

	DISPLAY	COMMENTS
	<b>System fault</b>	
1	Auto Test Failed	Auto Test does not pass
2	No Utility	No Grid Connect
3	PV Over Voltage	PV panel Voltage is too high
4	Isolation Fault	Insulation Problem of PV panel
5	GFCI Fault	leakage current is too high
6	Grid Freq. Fault	Grid frequency is out of range
7	Grid Volt. Fault	Grid voltage is out of range
	<b>Inverter fault</b>	
1	Consistent Fault	Consistent Fault
2	Over Temp. Fault	Internal temperature abnormal
3	Relay Fault	Output relay Fault
4	DCI Out Range	Output Current DC Offset too high
5	EEPROM Fail	EEPROM Fault
6	Comm. Lost	Communication Fault
7	Bus Over Voltage	DC Bus over-voltage
8	Bus Low Voltage	DC Bus under-voltage
9	Boost Fault	Boost Current or Voltage Fault
10	GFCI Device Fault	GFCI Device is damaged
11	Inv. Curr. Over	Inverter output current too high
12	Fan Lock	Fan Lock
13	RTC Fail	Real Time Clock IC Fault
14	SCI Fault	Communication Fault

## 5. COMMUNICATIONS

### 5.1 Data communication with RS232



Fig. 17 RS232 serial port and special RS232 cable

Open the cover of RS232 serial port, Connect solar Inverter and computer by JFY-tech special RS232 cable. By the way, the communication distance should be below 10m.

**NOTE:** Only JFY-tech special RS232 cable can work. If its length is not enough, you can buy “extended RS232 cable” in local market.

### 5.2 Data communication with RS485

#### 5.2.1 RS485 Serial Port

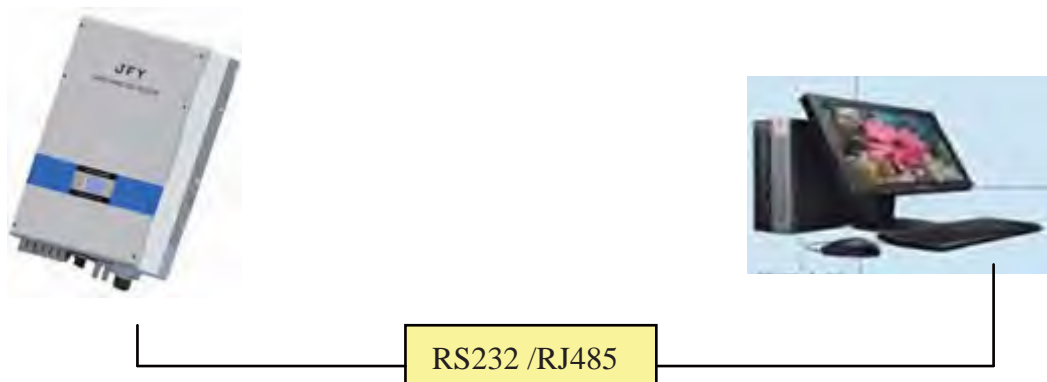

Fig.18 RS232 Communication Diagram

The RS485 is used for several inverters' communication. Ethernet cable is applied to connect each inverter herein. Only three cables in ethernet cable: two signal ones and one for ground connection.



Fig. 19 The waterproof RJ45 socket and connectors for RS485 port

To help installation, the inverter features two RJ45 sockets to separate input ethernet cable from output ethernet cable.

### 5.2.2 RJ45 Connectors

The RS485 serial connection, whether single unit or several inverters as daisy chain, can be performed by means of the RJ45 connectors (See Fig. 11).

It makes no difference if its sockets is no.1 or no.2 since they are connected in parallel, and signals are thus the same. One socket is for input ethernet cable with RJ45 connector, another socket is for output ethernet cable with RJ45 connector. The output ethernet cable reaches the following unit.

RS485 pin definition is as follows:

RJ45 connectors			
	Pin #	Signal Name	Description
	1		Not Used
	2		Not Used
	3	RTN	<b>Signal Return</b> Common reference for logical signals.
	4		Not Used
	5		Not Used
	6		Not Used
	7	-TR	- Data Line Required for RS485 communication.
	8	+TR	+ Data Line Required for RS485 communication.

**NOTE:** You can buy T-568B standard Straight-Through ethernet cable to connect two adjacent inverters in local market. Of course, you can do it by yourself and remember the ethernet cable is Straight-Through.

### 5.2.3 RS485 Daisy Chain

RJ45 connectors may be used to connect a single JFY-TECH inverter or multiple JFY-TECH inverters daisy chained together. Up to 31 inverters can be daisy chained. Recommended maximum daisy chain length is 1000m.

With multiple daisy-chained inverters, each unit will be automatically assigned a RS485 address with JFY monitoring software.

The RJ45 socket with 120Ω terminal resistor should be installed at the last inverter in the chain. JFY-tech provide a special RJ45 socket with terminal resistor and a vacant RJ45 socket in the attached accessories. When the inverter is not the last one in the chain, please draw out the terminal resistor and use it as a vacant RJ45 socket.

In order to ensure that the communication on the RS485 line is very safe, JFY-tech recommends connecting an isolating RS232-485 adapter between the first inverter in the daisy chain system and the computer. Of course, non-isolating RS232-485 adapter can also work.

The following diagram shows how to connect multiple inverters in a daisy chain configuration.

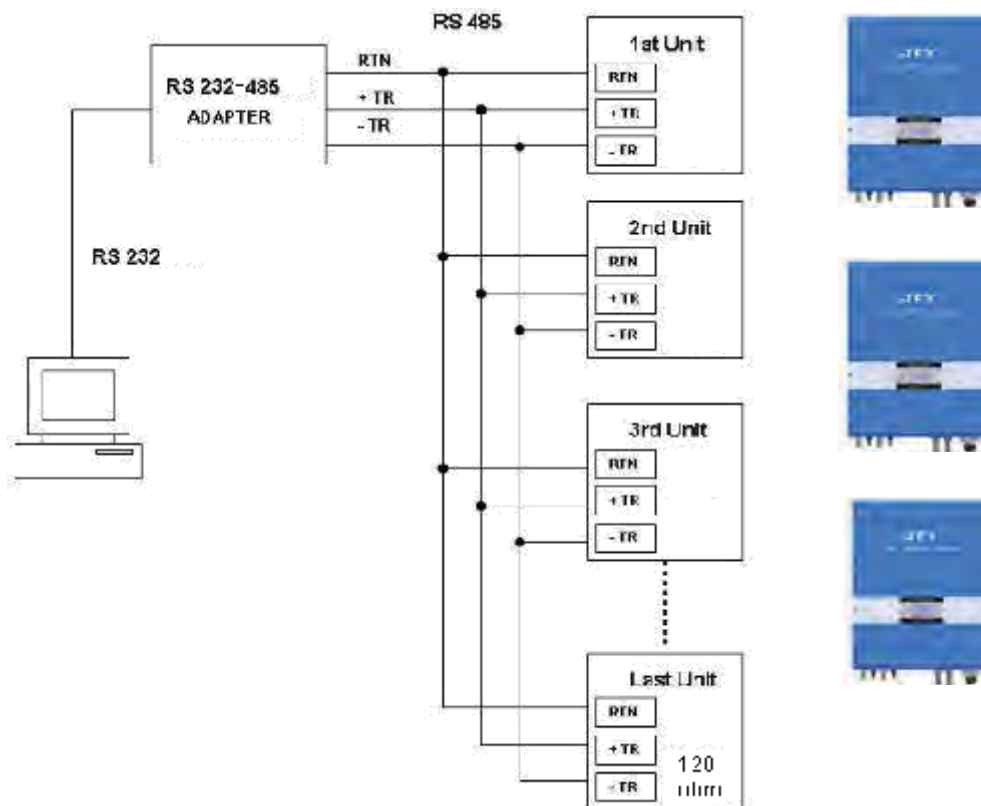

Fig.20 Multiple daisy-chain connection

**NOTE:** The RS485 link supports up to 31 inverters.

**NOTE:** The RJ45 socket with 120Ω terminal resistor should be installed at the last inverter in the chain. Even if there is only one inverter, the 120Ω terminal resistor is also necessary.

## 5.3 Monitor Inverter

After RS232 or RS485 link is connected correctly, open JFY monitoring software “JFY communicator” that is installed from the attached CD, the user can monitor the inverters. The right side of the main interface is the detailed information of inverter. As to more detailed setting methods and other functions, please refer to “JFY communicator user’s manual” in the CD.



## 6. INTERFACE PROTECTION AND SETTING POINTS

Incorporated interface protection is designed according to VDE\_4105/VDE\_0216, it is insensitive to normal voltage and frequency variations in AC grid.

The interface protections ensure that the inverter cease to energize AC grid when any parameters listed as below exceeds the applied operating setting points. Disconnection is provided in case of any hardware malfunctioning.

The solar inverter will cease to energize AC grid in response to an interface protection, it is achieved by the simple isolation of two internal AC relays in series.

Suntree xxxxxTL Default interface protection settings

Parameters	Setting trip time	Setting protection point
Over voltage	0.2s	264.5Vac
Under voltage	0.2s	193Vac
Over frequency	0.2s	51.5Hz
Under frequency	0.2s	47.5Hz
Loss of the Mains	120ms	---
DC injection current	120ms	500mA
PV array Insulation resistance	100ms	1Mohm
Reconnection time	60ms	---
Sudden change of residual current	300ms	30mA
	150ms	60mA
	40ms	150mA
Continuous change of residual current	0.2s	264.5Vac



**WARNING:** This product can cause current with a d.c. current component. Where a residual current-operated protective device (RCD) or monitoring device(RCM) is used for protection in case of direct or indirect contact, only an RCD or RDM of Type B is allowed on the supply side of this product.

## 7. TROUBLE SHOOTING

In most situations, the Inverter requires very little service. However, if Inverter is not able to work perfectly, please refer to the following instructions before calling your local dealer or service personnel.

If any problems arise, the “Alarm” LED on the front panel will be red and the LCD displays the relevant information. Please refer to the following table for a list of potential problems and their solutions.

	DISPLAY	HOW TO DO?
1	No any display in LCD or LED	Check PV-input connections
2	No Utility	Check grid connection cables.
3	PV Over Voltage	Check the Voc of PV string, see if it is greater than or too close to max. input DC voltage of relative inverter type.
4	Isolation Fault	Check the impedance is between PV (+) & PV (-) and the PV-Inverter is earthed. The impedance must be greater than 2MΩ
5	GFCI Fault	The leakage current is too high. Unplug the inputs from the PV string and check the peripheral AC system.
6	Grid Volt. Fault	Make sure grid voltage meet the specifications
7	Grid Freq. Fault	Make sure grid frequency meet the specifications

**NOTE:** During periods of little or no sunlight, the solar inverter may continuously start up and shut down. This is due to insufficient power generated to operate the control circuits, not a trouble.

**If you can not solve the trouble with above procedures, please contact your local dealer or service personnel. Don't open the inverter.**

Before contacting the authorized local dealer or service personnel, please find and keep at hand the following information:

**Information of Suntree xxxxxTL inverter**

1. Inverter Model
2. Serial Number
3. Week of manufacture

4. Which LED is red?
5. Which warning/error is displayed?
6. Do you notice whether warning/error can be repeated?

**Information of the PV array**

1. The model and manufacturer of the PV panels
2. Number of strings in the PV array and number of panels per string

## 8. SPECIFICATIONS

CHARACTERISTICS	SUNTREE 15000TL	SUNTREE 17000TL	SUNTREE 20000TL
Input Data(DC side)			
Max. DC power	15800W	17900W	21000W
Max. DC voltage	1000Vdc	1000Vdc	1000Vdc
MPPT Operating range	250~800Vdc	250~800Vdc	250~800Vdc
Number of inputs	6	6	6
Number of MPPT trackers	2	2	2
Max. input current(total)	60A (30A per tracker)	64A (32A per tracker)	70A (35A per tracker)
Output Data(AC side)			
Nominal output power	15000W	17000W	20000W
Max. Output power	15000W	17000W	20000W
AC type	3/N/PE	3/N/PE	3/N/PE
Nominal output current	22.7A per phase	25.8A per phase	30.3A per phase
Max. output current	24.3A per phase	27.5A per phase	32.3A per phase
Nominal AC voltage(L-L)	400Vac	400Vac	400Vac
Possible AC voltage range(L-L) *	330~480Vac	330~480Vac	330~480Vac
Nominal AC grid frequency	50Hz	50Hz	50Hz
Possible AC grid frequency range*	50 ± 5 Hz	50 ± 5 Hz	50 ± 5 Hz
Power factor(cos φ)	0.9(leading)~ 0.9 (lagging)	0.9(leading)~ 0.9 (lagging)	0.9(leading)~ 0.9 (lagging)
Harmonic distortion(THDI)	<3%(at nominal output power)	<3%(at nominal output power)	<3%(at nominal output power)

效率			
Max. efficiency	98.10%	98.10%	98.20%
Euro efficiency	97.50%	97.60%	97.60%
MPPT efficiency	99.60%	99.60%	99.60%
General data			
Dimensions (W / D / H)	474*165*670 mm		
Net weight	50Kg		
Operating temperature range	-25 °C ~ +60 °C		
Noise emission (typical)	≤ 25 dB(A)		
Power consumption at night	0 W		
Electrical isolation	Transformer-less		
Cooling concept	Fan cooling (IP54 fan)		
IP Code	IP65		
Communication	RS-485/RS-232		
* AC grid voltage range and frequency range depend on local standards.			

## 9. JFY-tech WARRANTY

### Warranty Policy:

**Warranty Period:** The JFY-TECH Series PV Grid-tied inverters provided by Shenzhen JingFuYuan Tech. Co., LTD. (abbr. JFY-tech) have 60-month warranty period. The system accessories provided by JFY-tech have 24-month warranty period.

**Warranty Time Start:** From the date that you get goods from our distributors.

**Warranty Evidence:** The Purchasing Invoice from the distributors & Product Series No.

**Note:** JFY-tech will count from 2 months later according to ex-factory date as the warranty start time if client fails to provide the purchasing invoice and other documents.

**Scope:** Any damages that occur during the WARRANTY PERIOD will be evaluated by Distributor and JFY-tech to define its scope and responsibility.

### Warranty Principles:

To provide better service to JFY-tech's end users, all JFY-tech's authorized distributors are requested to respond to end users' warranty claim, and the authorized distributors will replace any products or parts of the product during the warranty period proved to be defective in design or manufacture. The following cases will be excluded from the warranty (the Distributors are liable for investigation of the following):

- 1) "Warranty Card" not being sent back to distributor or JFY-tech.
- 2) Product modified or design changed or parts replaced not approved by JFY-tech.
- 3) Modifications, changes, or attempted repairs and erase series number or seals by non JFY-tech's technician.
- 4) Incorrect installation or commissioning
- 5) Failure to observe the applicable safety regulations (VDE\_4105/VDE\_0126 standards, etc.)
- 6) The Product has been improperly stored and damaged while being stored by the end user.
- 7) Transport damage, Painting scratch caused by shipping pumping. It should declare to insurance company as soon as containers unload with enough evidence.
- 8) Failure to observe the user manual, the installation guide, and the maintenance regulations
- 9) Incorrect use or inappropriate operation

- 10) Insufficient ventilation of the device
- 11) The maintenance procedures relating to such product have not been observed or performed to an acceptable standard.
- 12) Force majeure (e.g., lightning, overvoltage, storm, fire)

Claims that go beyond the rights cited in the warranty principles, in particular claims for compensation for direct or indirect damages arising from the defective device, for compensation for costs arising from disassembly and installation, or loss of profits are not covered by JFY-tech's warranty, insofar JFY-tech is not subject to statutory liability.

#### Warranty Claim Procedure:

Please report defective devices with a brief error description to the JFY-tech's distributors. If we agree to a replacement, we generally send an equivalent replacement device according to model and age, the remainder of the warranty entitlement will be transferred to the replacement device. In this case, you do not receive a new certificate since your entitlement is documented at JFY-tech. The replacement will be packaged appropriately for transport and shipped out within 2 working days. The defective device is to be packed in this transport packaging for return transport to the distributor. If the on-site service of re-installation is necessary, the end customers need to negotiate with the distributors in advance. All warranty services in warranty period are free of charge.

## **10. JFY-tech CONTACT INFORMATION**

Shenzhen JingFuYuan Tech. Co., LTD.

ADD: 5<sup>th</sup> Floor ,12<sup>th</sup> Block ,Nangang Second Industrial Park ,Nanshan  
District ,Shenzhen ,P.R.China

Tel: +86-755-26632536

Fax: +86-755-26505986

Email: [support@jfy-tech.com](mailto:support@jfy-tech.com)